

Operating instructions Electronic Moisture Analyzer

KERN DLB_A

Version 1.0
04/2011
GB





KERN DLB_A

Version 1.0 04/2011

Operating instructions Electronic Moisture Analyser

Contents

1	Technical data	4
2	Appliance overview	6
2.1	Keyboard and display overview	9
3	Basic Information (General)	10
3.1	Proper use	10
3.2	Improper Use	10
3.3	Warranty	10
3.4	Monitoring of Test Resources	10
3.5	Danger Information	11
4	Basic Safety Precautions	12
4.1	Pay attention to the instructions in the Operation Manual	12
4.2	Personnel training	12
5	Transport and storage	12
5.1	Testing upon acceptance	12
5.2	Packaging / return transport	12
6	Unpacking, Setup and Commissioning	12
6.1	Installation Site, Location of Use	12
6.2	Unpacking and erection	14
6.2.1	Scope of delivery	15
6.3	Mains connection	15
6.4	Connection of peripheral devices	16
6.5	Initial Commissioning	16
7	Weighing	17
8	Adjustment	18
8.1	Adjust balance	18
8.2	Calibrate / adjust temperature	19
8.2.1	Calibrate temperature	21
8.2.2	Adjust temperature	22
9	Appliance configuration	23
9.1	Baud rate	25
9.2	Auto Zero	26
9.3	Filter	28
9.4	Standstill control display	29
9.5	Display background illumination	30

10	Operator menu – moisture analysis	31
10.1	How to implement drying.....	32
10.1.1	Moisture analysis with drying program PrG1 – PrG5	33
10.1.2	Moisture analysis with drying program PrG time	37
10.1.3	Moisture analysis with drying program PrG Auto Mode	40
10.2	Save the drying programs PrG1, PrG2, PrG3, PrG4, PrG5	44
11	RS 232C interface	46
11.1	Technical data.....	46
11.2	Pin allocation of the output plug	46
11.3	Menu settings „Serial“	47
11.3.1	Printout examples (YKB-01N)	48
12	General information concerning moisture analysis	49
12.1	Application	49
12.2	Basics	49
12.3	Adjustment to existing measuring method.....	49
12.4	Preparing a sample.....	50
12.5	Sample material	51
12.6	Sample size / originally weighted in quantity	51
12.7	Drying temperature.....	52
12.8	Recommendations / Guidelines	52
13	Error messages	56
14	Service, maintenance, disposal.....	57
14.1	Cleaning.....	57
14.2	Service, maintenance	57
14.3	Disposal.....	57
15	Instant help.....	58
16	Declaration of conformity	59
17	Short instructions for moisture analysis	60

1 Technical data

Data	DLB 160-3A	
Radiator	Halogen (1 x 400 W)	
Temperature range	35°C - 160°C Choice of steps at 1°C	
Maximum load (Max)	160 g	
Warm-up time	120 min	
Minimum for drying	0.5 g	
Readability (d)	Weighing mode	0.001g
	Moisture analysis mode	0.01 %
Reproducibility	Weighing mode	0.001g
	Moisture analysis mode	Weighed in quantity 10 g: 0.03 %
Linearity	± 0.003 g	
Stabilization time (typical)	4 sec.	
Recommended adjustment weight, not added (class)	100g (E2)	
Environmental conditions	<ul style="list-style-type: none"> • 5°C....+40°C ambient temperature • 45% - 75% air humidity non-condensing 	

Shutoff criterion	<p>1. Time mode Drying is finished after the set time, adjustable 1 – 99 minutes.</p> <p>2. Auto mode Drying is completed, when the set weight value per time unit is lower than the nominal value, 0.1 – 9.9 % loss of weight adjustable.</p>
Sample dishes included	Ø 100 mm
Result display	<p>[g] residual weight</p> <p>[%] moisture</p> <p>[%] dry mass:</p> <p>ATRO [%] = Start weight : Residual weight x 100%</p>
Internal memory	5 memory locations for drying programs
Interface	RS232
Dimensions	Housing 210 x 340 x 225 mm
Available drying room	Ø 100 mm, 20 mm high
Net weight	4.2 kg
Electric Supply	230V AC 50Hz
Mains adapter	9V AC, 1000mA

2 Appliance overview



Pos.	Description
1	Foldable hood
2	Temperature sensor
3	Sample dish
4	Heating top
5	Balance
6	Display
7	Keyboard
8	Levelling screw

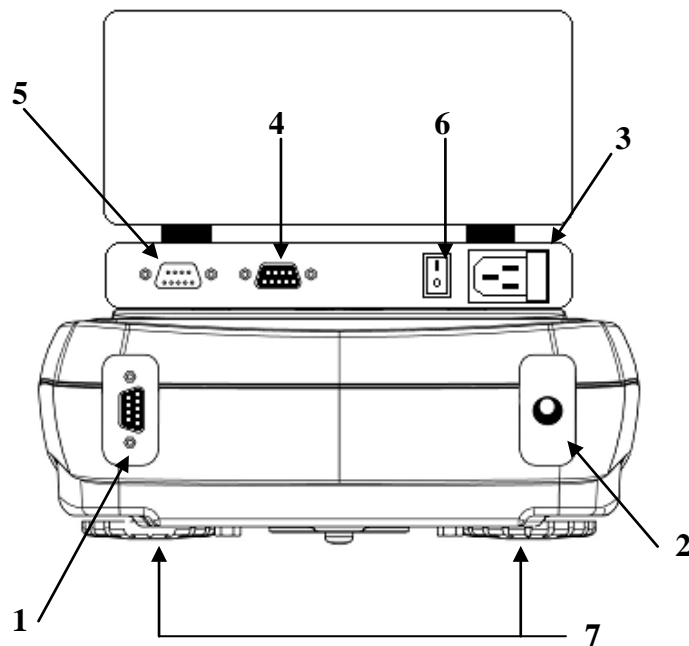

1. Plug-in connection cable „Balance / Heating top“
2. Connection net adapter „Balance“.
3. Current supply „Heating top“.
4. RS 232 interface
5. Plug-in connection cable „Balance / Heating top“
6. Main switch „Heating top“
7. Adjustable foot screws

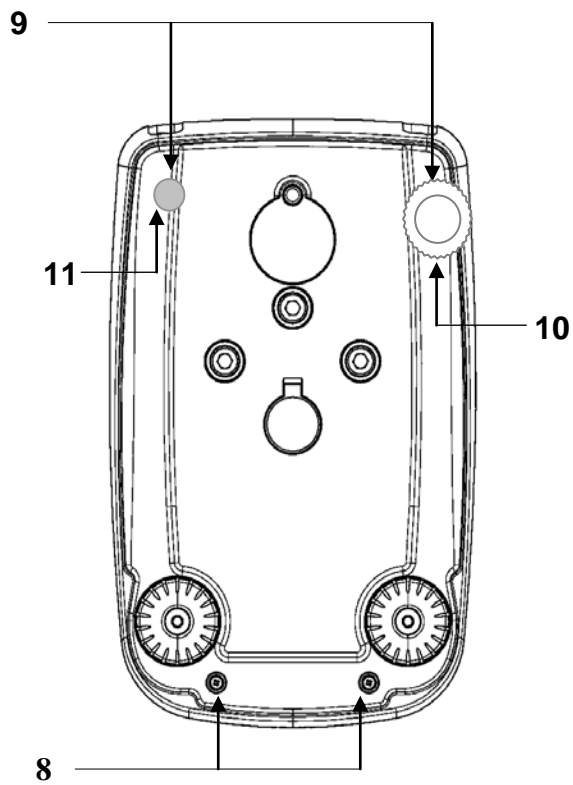

- 8. Housing screws
- 9. Housing screws (for access remove the foot screws)
- 10. Adjustable foot screws
- 11. Rigid foot screw

2.1 Keyboard and display overview

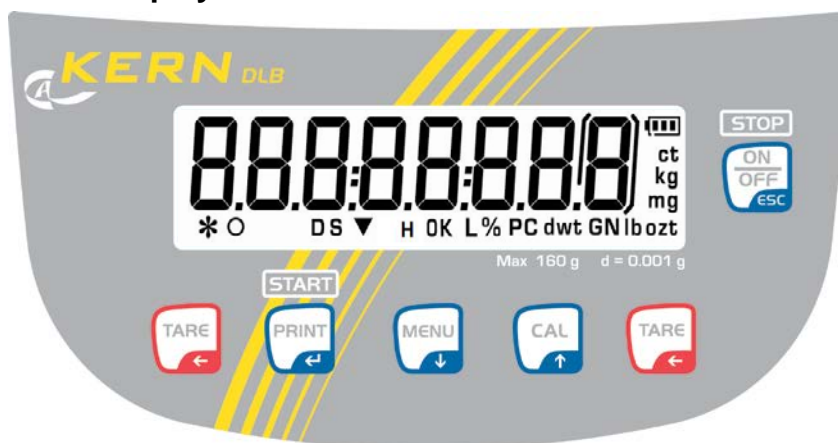

Display	Description
○	Zero indicator
*	Stability display
%	Display of percentage
▼	Status „Weighted in quantity sample“
H	Drying process active
g	Gram display

Key	Description	Description
	MENU button/ Navigation button ▼	Short key pressing
		<ul style="list-style-type: none"> Invoke user menu Switch over display of result
	ON/OFF button	Long time pressed button until the acoustic signal gets mute
		<ul style="list-style-type: none"> Invoke / exit configuration menu
	CAL button/ Navigation button ▲	<ul style="list-style-type: none"> Adjustment
		<ul style="list-style-type: none"> Select menu items – scroll backward
	START PRINT button Navigation button ◀	<ul style="list-style-type: none"> Start drying Calculate weighing data via interface
		<ul style="list-style-type: none"> Confirm / store settings
	TARE button	<ul style="list-style-type: none"> Taring Zeroing

3 Basic Information (General)

3.1 Proper use

The device purchased by you is designed for a fast and reliable determination of material moisture in liquid, porous and solid materials by applying the method of thermogravimetrics.

3.2 Improper Use

Impacts and overloading exceeding the stated maximum load (max) of the device, minus a possibly existing tare load, must be strictly avoided.

This could damage the instrument.

Never operate device in explosive environment. The serial version is not explosion protected.

Changes to the unit's design are not permitted. This may lead to incorrect weighing results, safety-related faults and destruction of the appliance.

The unit may only be operated in accordance with the described default settings. Other areas of use must be released by KERN in writing.

3.3 Warranty

Loss of warranty due to

- Our conditions in the operation manual are ignored
- The appliance is used outside the described uses
- The appliance is modified or opened
- mechanical damage and damage caused by media, liquids
- natural wear and tear
- The appliance is improperly set up or incorrectly electrically connected
- The measuring system is overloaded

3.4 Monitoring of Test Resources

In the framework of quality assurance the measuring-related properties of the moisture analyser and, if applicable, the testing weight, must be checked regularly. The responsible user must define a suitable interval as well as type and scope of this test. Information is available on KERN's home page (www.kern-sohn.com) with regard to the monitoring of balance test substances and the test weights required for this. In KERN's accredited DKD calibration laboratory test weights and balances may be calibrated (return to the national standard) fast and at moderate cost.

3.5 Danger Information

Individual parts of the case (e. g. the ventilation grids) may heat up considerably during operation. For this reason, please touch the device only at the designated handles. Sample materials developing aggressive vapours (e. g. acids) may cause corrosion problems on some parts of the device. The moisture meters should mainly be used for drying aqueous substances. Explosion prone, flammable samples must not be analysed using the moisture meter.



⇒ Do not open or touch drying chambers during the drying process as the device develops very high temperatures. Even after finishing the measurement the appliance remains hot.



- Careful when removing the sample. The sample itself, the sample dish and the heating unit may be very hot.



- Do not use the moisture meter for analysing explosion prone, easily flammable samples.

- Do not operate the humidity analyser in areas with hazard of explosion



- Sample materials emitting toxic substances must be dried with a special extraction system in place. Create an environment that prevents the inhalation of vapours hazardous to health.

- Do not place combustible materials on, under or next to the device.



- Ensure that there is sufficient empty space around the device in order to prevent heat accumulation (distance to device 20 cm, above it 1m).

- Make sure that liquids do not get in contact with the interior of the device or the connections at the rear of the device. If you spill liquid on the device, disconnect it immediately. Afterwards do not operate the appliance and have it checked by a competent KERN stockist before any further use.

4 Basic Safety Precautions

4.1 Pay attention to the instructions in the Operation Manual



Carefully read this operation manual before setup and commissioning, even if you are already familiar with KERN appliances.

4.2 Personnel training

The appliance may only be operated and maintained by trained personnel.

5 Transport and storage

5.1 Testing upon acceptance

When receiving the appliance, please check packaging immediately, and the appliance itself when unpacking for possible visible damage.

5.2 Packaging / return transport



- ⇒ Keep all parts of the original packaging for a possibly required return.
- ⇒ Only use original packaging for returning.
- ⇒ Prior to dispatch disconnect all cables and remove loose/mobile parts.
- ⇒ Reattach possibly supplied transport securing devices.
- ⇒ Secure all parts such as the glass wind screen, the weighing platform, power unit etc. against shifting and damage.

6 Unpacking, Setup and Commissioning

6.1 Installation Site, Location of Use

The unit is designed to achieve reliable weighing results under normal conditions of use.

You will work accurately and fast, if you select the right location for the appliance.

On the installation site observe the following:



1. Avoid extreme heat as well as temperature fluctuation caused by installing next to a radiator or in the direct sunlight;

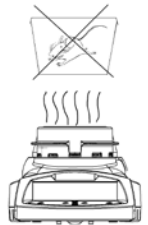

2. Remove explosion prone, easily flammable material in the immediate vicinity. Emerging vapours, sample dish and all parts of the sample chamber are hot!

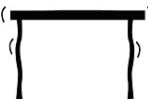

3. Place the device on a firm, level surface.

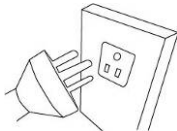

4. Major display deviations (incorrect weighing results) may be experienced should electromagnetic fields (e.g. due to mobile phones or radio equipment), static electricity accumulations or instable power supply occur. Change location or remove source of interference.

5. Avoid static charging of the material to be weighed, weighing container and windshield

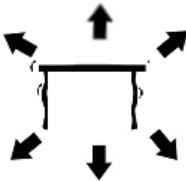

6. Avoid jarring during weighing.



7. Protect the appliance against high humidity, vapours and dust,
8. Do not expose the device to extreme dampness for longer periods of time. Non-permitted condensation (condensation of air humidity on the appliance) may occur if a cold appliance is taken to a considerably warmer environment. In this case, acclimatize the disconnected appliance for ca. 2 hours at room temperature.



9. Protect the device against direct draughts due to open windows and doors.

6.2 Unpacking and erection

Take the appliance carefully out of its packaging, remove the plastic jacket and install it at the designated work space.

The appliance is supplied part-assembled. Immediately after unpacking check if the delivered items are complete. Assemble the separate component parts according to their sequence.



1. Put cover into the weighing chamber.
2. Put on the dish retainer carefully.
3. Position removal aid in a way that the handle fits under the groove of the cover.
4. Put sample dish on the dish holder.
5. Level the appliance with the help of the foot screws until it is standing evenly.

6.2.1 Scope of delivery

Serial accessories:

- Moisture analyzer, see chap. 2
- 10 sample dishes
- Power cable
- Mains adapter
- Connection cable „Balance / Heating top“
- Operating instructions

6.3 Mains connection



1. Power is supplied to the balance via the external power unit. The stated voltage value must be the same as the local voltage. Only use original KERN mains adapters. Using other makes requires consent by KERN. After connection to the power supply the balance will carry out a self-test. The balance changes into stand-by mode.



To switch on press the **ON/OFF** button. As soon as the weight display appears, the balance is ready for weighing.

2. Power supply to the heating top is provided via the supplied mains cable. Do not connect the appliance to the power grid unless the information on the appliance (sticker) matches the local mains voltage.
To switch on, press the main switch on the rear side of the appliance.
3. Attach the connection cable balance / heating top.



The appliance must be connected to a standard socket with earth terminal. Do not eliminate the protective effect by using an extension lead without earth terminal. For power supplies from power grids without earth terminals call a specialist to establish equivalent protection according to the relevant installation regulations.

6.4 Connection of peripheral devices

Before connecting or disconnecting of additional devices (printer, PC) to the data interface, always disconnect the moisture analyser from the power supply. Only use accessories and peripheral devices by KERN, as they are ideally tuned to the appliance.

6.5 Initial Commissioning

In order to obtain exact results with the electronic balances, your balance must have reached the operating temperature (see warming up time chap. During this warming up time the balance must be connected to the power supply (mains, accumulator or battery).

The accuracy of the balance depends on the local acceleration of gravity. Strictly observe hints in chapter Adjustment.

7 Weighing

Start-up

1. In stand-by mode (see chap. 6.3) press **ON/OFF** button. As soon as the weight display appears, the balance is ready for weighing.



Switching Off

2. Press the **ON/OFF** button, the balance returns into stand-by mode.



Simple weighing

3. Place goods to be weighed on balance.
4. Wait until the stability display appears [*****]

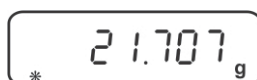

5. Read weighing result.

Taring

6. Place the weighing box and press the **TARE** button. „0-t“ is displayed.

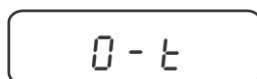

7. After standstill control the zero display appears.

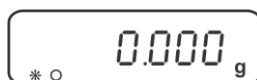

The weight of the container is now internally saved.

8. Weigh the material, the net weight will be indicated.

After removing the weighing container, the weight of the weighing container appears as negative display.

The tare weight is saved until it is deleted. Remove the load from the balance and press the **TARE** button. „0-t“ is displayed, wait until the zero display appears.

The tare procedure can be repeated as many times as necessary, for example with initial weighing of several components for a mix (add-on weighing). The limit is reached when the total weighing range capacity is full.

8 Adjustment

8.1 Adjust balance

As the acceleration value due to gravity is not the same at every location on earth, each balance must be coordinated - in compliance with the underlying physical weighing principle - to the existing acceleration due to gravity at its place of location (only if the balance has not already been adjusted to the location in the factory). This adjustment process must be carried out for the first commissioning, after each change of location as well as in case of fluctuating environment temperature. To receive accurate measuring values it is also recommended to adjust the balance periodically in weighing operation.



- Observe stable environmental conditions. A warming up time (see chapter 1) is required for stabilization.
- Carry out adjustment with placed sample dish. Ensure that no objects are within the sample dish.
- Weight value of the required adjustment weight see chpt. 1 "Technical specifications":



⇒ In weighing mode press the **CAL** button.

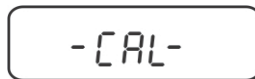

⇒ Wait until the weighed value for the required adjustment weight appears flashing.

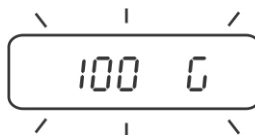

Example 100 g

⇒ **During** the flashing display put the required adjustment weight carefully in the centre of the sample dish. The flashing display disappears. After successful adjustment the balance automatically returns to weighing mode.

⇒ Take away adjustment weight

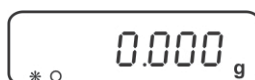

In case of an adjustment error (e.g. objects on the weighing plate) the display will show an error message, repeat adjustment.

8.2 Calibrate / adjust temperature

We recommend sometimes to check the temperature value of the device using the optional temperature calibrating set DLB-A01. Before you do this, allow the device to cool down for at least 3 hours after the last heating phase.

Preparation:

⇒ Remove the separate component parts „sample dish“ according to their sequence



⇒ Install the temperature-calibration set acc. to fig..



- ⇒ Switch-on the heating top on the rear side.
- ⇒ Close cover of the heating top
- ⇒ On the temperature calibration set switch-on the digital thermometer by the **ON** button.

Invoke service function:

- ⇒ In weighing mode press the **MENU** button, the menu item „Therm“ will be displayed.

ThErM

- ⇒ Confirm by pressing the **PRINT** button. Press repeatedly the **MENU** button until „Service“ will be displayed.

SERvICE

- ⇒ Keep pressed the **PRINT** button for **2 sec**. Select the desired settings by pressing the **MENU** button

tNP tEst

Temperature calibration



tNP AdJ

Temperature adjustment



HEAt SEL

Settings of lamp

8.2.1 Calibrate temperature

During temperature calibration only a check is carried out, i.e. no values are changed.

- ⇒ Invoke service function „Tmp test“, see chap. 8.2.

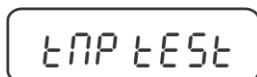

- ⇒ Confirm by pressing the **PRINT** button. The current setting will be displayed. Use the navigation buttons **↓** **↑** to select the temperature during the check, available 35- 160°C.

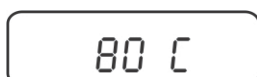

- ⇒ Confirm using the **PRINT** button, the appliance heats up to the set temperature. After approx. 15 minutes compare the temperature displayed on the thermometer with that of the moisture analyzer. If the two values do not match, we recommend a temperature adjustment, see chap. 8.2.2.
- ⇒ Use the **ON/OFF** button to finish the calibration.
- ⇒ Use the **ON/OFF** button to return into weighing mode.

8.2.2 Adjust temperature

The temperature is measured at two selectable points and it is possible to correct it there.

- ⇒ Invoke service function „Tmp Adj“, see chap. 8.2.

tNP Adj

- ⇒ Confirm by pressing the **PRINT** button. The current setting for the first temperature point is displayed. Or leave it on factory setting 80°C or select a desired temperature with the help of the navigation buttons ↓ ↑ (available 50-130°C).

P1 80 C

- ⇒ Confirm with the **PRINT** button, the first heat-up phase is started. The remaining time is displayed.

15 min

- ⇒ Temperature calibration of first point will take 15 min. Compare the temperature displayed on the thermometer with that of the moisture analyzer. If the two values do not match, correct them using the navigation buttons ↓ ↑ and confirm with the **PRINT** button

t1 80 C

- ⇒ The current setting for the second temperature point is displayed. Or leave it on factory setting 150°C or select the desired temperature with the help of the navigation buttons ↓ ↑. The second temperature point has to be at least 30°C over the first one, max. 160°C.

P2 150 C

- ⇒ Confirm with the **PRINT** button, the second heat-up phase is started. The remaining time is displayed.

15 min

- ⇒ Temperature calibration of the second point will take 15 min. Compare the temperature displayed on the thermometer with that of the moisture analyzer. If the two values do not match, correct with the help of the navigation buttons ↓ ↑.

t2 150 C

- ⇒ Confirm by pressing the **PRINT** button. The adjustment is completed, the appliance returns into the menu. Use the **ON/OFF** button to return into weighing mode.

9 Appliance configuration

Via the configuration menu the appliance can be individually adapted to your weighing needs.

Navigation in the menu

Access to menu	In weighing mode press the MENU button and keep it pressed until the acoustic signal gets mute. Release the button, the first menu point „bAud rt“ is displayed.
How to select menu items	Using the MENU button the individual menu items can be selected one after the other. ⇒ Scroll forward using navigation button ↓ (MENU button) ⇒ Scroll backward using navigation button ↑ (CAL button)
Change settings	Acknowledge selected menu item using PRINT button, the current setting is displayed. Each time the navigation buttons ↓ ↑ are pressed the next setting will be displayed. ⇒ Scroll forward using navigation button ↓ (MENU button) ⇒ Scroll backward using navigation button ↑ (CAL button)
Save settings	Take over selection using the PRINT button. Weighing balance returns to menu. Either make more settings in the menu or go back to menu mode as follows.
Exit menu/ back to weighing mode	Press the MENU button and keep it pressed until the acoustic signal gets mute. The balance returns automatically into weighing mode.

Menu overview

Menu item	Display	Selection	Description
Baudrate (siehe Kap. 9.1)	bAud rt	br 1200	
		br 2400	
		br 4800	
		br 9600	
Automatic zero point correction (see chap. 9.2)	Auto 0	Au0 OFF	Auto Zero switched off
		Au0 1	Auto Zero range $\pm \frac{1}{2}$ digit
		Au0 2	Auto Zero range ± 3 digits
		Au0 3	Auto Zero range ± 7 digits
		Au0 3E	Auto Zero range ± 7 digits in the whole weighing range
Filter (see chap. 9.3)	FiltEr	Filt 1	Setting for dispensing
		Filt 2	Sensitive and fast, very quiet set-up location.
		Filt 3	Robust but slow, busy set-up location.
Stability display (see chap. 9.4)	StAbil	Stab 1	Standstill control fast / very quiet set-up location
		Stab 2	Standstill control fast + exact/ quiet set-up location
		Stab 3	Standstill control exact /very set-up location.
Background illumination of the display (see chap. 9.5)	Blit	on	Background illumination on
		off	Background illumination off
		Auto	Backlighting automatically switched off 3 seconds after achieving stable weighing value. Changes in weight or pressing of keys will automatically result in backlight switching on again.
	End		

Description of individual menu items:

9.1 Baud rate

⇒ In weighing mode press the **MENU** button and keep it pressed until the acoustic signal gets mute.



bAud rt

⇒ Acknowledge using **PRINT** button, the current setting is displayed.

⇒ Use the navigation buttons ↓ ↑ to select the desired setting.

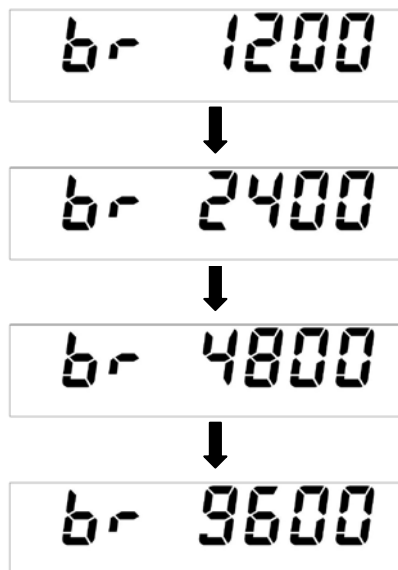

br 1200

↓

br 2400

↓

br 4800

↓

br 9600

⇒ Take over selection using the **PRINT** button.
Weighing balance returns to menu. Either make more settings in the menu or go back to weighing mode as follows.

⇒ Press the **MENU** button and keep it pressed until the acoustic signal gets mute.
The balance returns automatically into weighing mode.



* O 0.000 g

9.2 Auto Zero

Under this menu item the automatic zero point correction can be switched on or off. In switched-on-state the zero point is automatically corrected at drift or when dirty.

Note:

In the event that small quantities are removed or added to the material to be weighed, incorrect weighing results can be displayed due to the “stability compensation”. (e.g. slow flow of liquids from a container placed on the balance, evaporating processes). When apportioning involves small variations of weight, it is advisable to switch off this function.

- ⇒ In weighing mode press the **MENU** button and keep it pressed until the acoustic signal gets mute.

A rectangular digital display showing the text "bAud rt" in a black, pixelated font on a white background.

- ⇒ Press **MENU** button repeatedly

A rectangular digital display showing the text "Auto 0" in a black, pixelated font on a white background.

- ⇒ Acknowledge using **PRINT** button, the current setting is displayed.

Use the navigation buttons ↓ ↑ to select the desired setting.

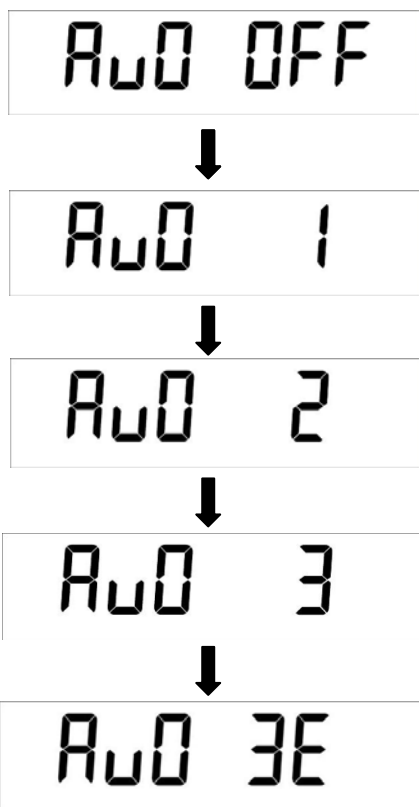

- Au0 OFF** = Auto Zero switched off
- Au0 1** = Auto Zero range $\pm \frac{1}{2}$ digit
- Au0 2** = Auto Zero range ± 3 digits
- Au0 3** = Auto Zero range ± 7 digits
- Au0 3E** = Auto Zero range ± 7 digits in the whole weighing range

- ⇒ Take over selection using the **PRINT** button.
Weighing balance returns to menu. Either make more settings in the menu or go back to weighing mode as follows.
- ⇒ Press the **MENU** button and keep it pressed until the acoustic signal gets mute.
The balance returns automatically into weighing mode.



9.3 Filter

This menu item allows the balance to be set according to specific ambient conditions and measuring purposes.

- ⇒ In weighing mode press the **MENU** button and keep it pressed until the acoustic signal gets mute.

The LCD display shows the text "bAud rt" in a black dot-matrix font on a white background.

- ⇒ Press **MENU** button repeatedly

The LCD display shows the text "F, 1kE-" in a black dot-matrix font on a white background.

- ⇒ Acknowledge using **PRINT** button, the current setting is displayed.
- ⇒ Use the navigation buttons \downarrow \uparrow to select the desired setting.

The LCD display shows the text "F, 1kE-1" in a black dot-matrix font on a white background.



The LCD display shows the text "F, 1kE-2" in a black dot-matrix font on a white background.



The LCD display shows the text "F, 1kE-3" in a black dot-matrix font on a white background.

Filter 1: Setting for dispensing

Filter 2: The balance reacts quickly and in a sensitive manner, very quiet set-up location.

Filter 3: The balance reacts slowly and in a robust manner, busy set-up location

- ⇒ Take over selection using the **PRINT** button. Weighing balance returns to menu. Either make more settings in the menu or go back to weighing mode as follows.
- ⇒ Press the **MENU** button and keep it pressed until the acoustic signal gets mute. The balance returns automatically into weighing mode.

The LCD display shows "0.000" in a large black dot-matrix font, followed by a small "g" unit symbol. In the bottom left corner, there is a small "* O" symbol.

9.4 Standstill control display

- ⇒ In weighing mode press the **MENU** button and keep it pressed until the acoustic signal gets mute.



- ⇒ Press **MENU** button repeatedly

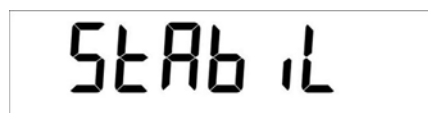

- ⇒ Acknowledge using **PRINT** button, the current setting is displayed.

- ⇒ Use the navigation buttons **↓** **↑** to select the desired setting.

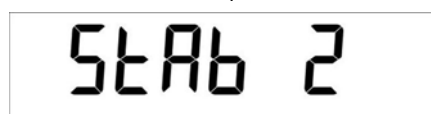

Stab 1: Standstill control fast / very quiet set-up location

Stab 2: Standstill control fast + exact / quiet set-up location

Stab 3: Standstill control exact / very set-up location.

- ⇒ Take over selection using the **PRINT** button.
Weighing balance returns to menu. Either make more settings in the menu or go back to weighing mode as follows.
- ⇒ Press the **MENU** button and keep it pressed until the acoustic signal gets mute.
The balance returns automatically into weighing mode.



9.5 Display background illumination

⇒ In weighing mode press the **MENU** button and keep it pressed until the acoustic signal gets mute.

A rectangular box containing the text "bAud rt" in a digital font.

⇒ Press **MENU** button repeatedly

A rectangular box containing the text "bLt" in a digital font.

⇒ Acknowledge using **PRINT** button, the current setting is displayed.

⇒ Use the navigation buttons **↓** **↑** to select the desired setting.

A rectangular box containing the text "ON" in a digital font.



A rectangular box containing the text "OFF" in a digital font.



A rectangular box containing the text "Auto" in a digital font.

ON Background illumination on

OFF Background illumination off

Auto Backlighting automatically switched off 3 seconds after achieving stable weighing value. Changes in weight or pressing of keys will automatically result in backlight switching on again

⇒ Take over selection using the **PRINT** button.
Weighing balance returns to menu. Either make more settings in the menu or go back to weighing mode as follows.

⇒ Press the **MENU** button and keep it pressed until the acoustic signal gets mute.
The balance returns automatically into weighing mode.

A rectangular box containing a digital display. On the right, it shows "0.000" followed by a small "g". On the left, it shows "* O".

10 Operator menu – moisture analysis

Menu selection:

PrG 1

PrG 2

PrG 3

PrG 4

PrG 5

The appliance offers the possibility to occupy and to save 5 different drying programs (Prg1, Prg2, Prg3, Prg4, Prg5) with individual drying parameters which may be invoked and started whenever necessary.

PrG time

Time drying mode:

Drying is completed after the set time, adjustable:

Drying time 1 – 99 minutes

Temperature 35 – 160 °C

PrG Auto

Autostop drying mode:

Drying is completed, when a weight constancy has been reached.

Options:

Weight loss 0.1 - 9.9%

Temperature 35 – 160 °C



Short instructions for moisture analysis, see chap. 17

10.1 How to implement drying

Place removal aid with empty sample dish on the sample dish retainer. Make sure that the sample dish is resting flat on the sample dish retainer. Use the sample retainer at all times as it allows safe working and prevents burns.

Prior to start the moisture analysis select a suitable drying program.

⇒ In weighing mode press the **MENU** button, „Therm“ is displayed.

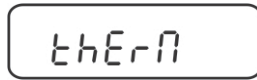
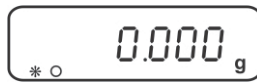

⇒ Acknowledge using **PRINT** button, „Measure“ is displayed.

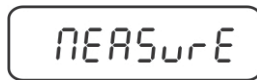

⇒ Acknowledge using **PRINT** button, the current setting is displayed.

⇒ Use the navigation buttons **↓** **↑** to select the desired drying program.

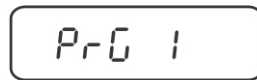

.....

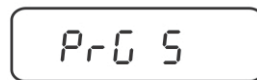

s. chap. 10.1.1

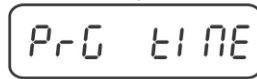

s. chap. 10.1.2

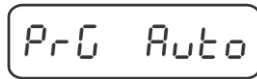

s. chap. 10.1.3

10.1.1 Moisture analysis with drying program PrG1 – PrG5

After invoking a drying program PrG1, PrG2, PrG3, PrG4 or PrG5 previously stored (see chap. 10.2) you are queried whether the preheating stage „PrH“ shall be connected.

i If the preheating stage is added, the appliance will heat up to the set temperature before starting the drying.

PrG 1

⇒ Confirm the selected drying program, e.g. PrG1 (see chap. 10.1) using the **PRINT** button. The query whether the preheating stage „PrH“ shall be connected, will appear.

PrH no



PrH YES

⇒ Use the navigation buttons **↓** **↑** to select the desired setting.

PrH no = preheating stage switched off

PrH yes = preheating stage connected

Start of moisture analysis:

Preheating stage enabled



- ⇒ Confirm by the **PRINT** button, close the sample chamber and wait for the warm-up phase.



- ⇒ After reaching the set temperature „ready“ will be displayed.



- ⇒ Confirm by pressing the **PRINT** button. The weight display and the indicator „▼“ are displayed.
- ⇒ If required, tare by using **TARE** button.

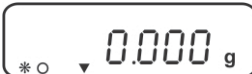

- ⇒ Put prepared sample (see chap. 12.4) in the sample dish and close the sample chamber.

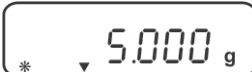

- ⇒ Wait for stability display, then press the **PRINT** button. Drying is started.



The result display appears.

The indicator „H“ displays the active drying process.

Preheating stage disabled



- ⇒ Confirm by pressing the **PRINT** button. The weight display and the indicator „▼“ are displayed.
- ⇒ If required, tare by using **TARE** button.



- ⇒ Put prepared sample (see chap. 12.4) in the sample dish and close the sample chamber.

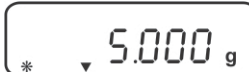

- ⇒ Wait for stability display, then press the **PRINT** button. Drying is started.



The result display appears.

The indicator „H“ displays the active drying process.

- ⇒ During drying the display can be switched over by repeated pressing of the **MENU** button.

Moisture [%] = loss of weight (GV) from start weight (SG)

0 – 100%



Dry mass [%] = residual weight (RG) of SG

100% - 0 %



ATRO [%] = $SG : RG \times 100\%$

100 – 999 %



Current temperature



Remaining time

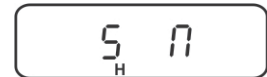

Using the **ON/OFF** button drying can be finished at any moment if required.

- ⇒ When drying is finished, you will hear an acoustic signal and the heating will be shut off. The indicator „OK“ displays the measuring result. Use the **MENU** button to switch over into the result display.



Moisture [%]



Dry mass [%]



ATRO [%]



Residual weight in „g“

- ⇒ When an optional printer is connected, the measurement log will be edited independently on the settings in the menu, see chap. 11.3
- ⇒ For further measurement press the **ON/OFF** button, the appliance returns into the menu.
- ⇒ For exiting the menu press anew the **ON/OFF** button, the appliance returns into weighing mode
- ⇒ Open the sample chamber and remove the sample with the help of the removal aid.

Caution: Caution! Sample dish and all parts of the sample chamber are hot!

10.1.2 Moisture analysis with drying program PrG time

After setting the drying time (available 1 -99 Min) and the drying temperature (available 35 – 160°C), moisture will be analyzed with the help of these two parameters.

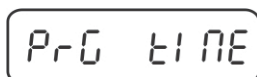

PrG TIME

⇒ Confirm by pressing the **PRINT** button. The currently set drying time is displayed.

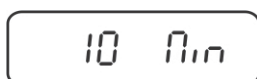

10 Min

⇒ Use the navigation buttons **↓** **↑** to select the desired setting.

⇒ Confirm by pressing the **PRINT** button. The currently set drying temperature is displayed.

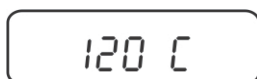

120 C

⇒ Use the navigation buttons **↓** **↑** to select the desired setting.

⇒ Confirm by pressing the **PRINT** button. The query whether the preheating stage „PrH“ shall be connected, will appear.

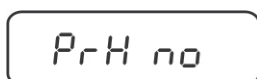

PrH no

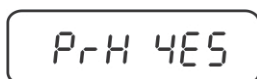

PrH YES

⇒ Use the navigation buttons **↓** **↑** to select the desired setting.

PrH no = preheating stage switched off

PrH yes = preheating stage connected

Start of moisture analysis:

Preheating stage enabled



- ⇒ Confirm by the **PRINT** button, close the sample chamber and wait for the warm-up phase.



- ⇒ After reaching the set temperature „ready“ will be displayed.



- ⇒ Confirm by pressing the **PRINT** button. The weight display and the indicator „▼“ are displayed.
- ⇒ If required, tare by using **TARE** button.



- ⇒ Put prepared sample (see chap. 12.4) in the sample dish and close the sample chamber.

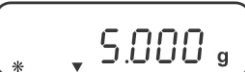

- ⇒ Wait for stability display, then press the **PRINT** button. Drying is started.



The result display appears.

The indicator „H“ displays the active drying process.

Preheating stage disabled



- ⇒ Confirm by pressing the **PRINT** button. The weight display and the indicator „▼“ are displayed.
- ⇒ If required, tare by using **TARE** button.



- ⇒ Put prepared sample (see chap. 12.4) in the sample dish and close the sample chamber.

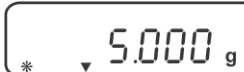

- ⇒ Wait for stability display, then press the **PRINT** button. Drying is started.



The result display appears.

The indicator „H“ displays the active drying process.

- ⇒ During drying the display can be switched over by repeated pressing of the **MENU** button.

Moisture [%] = loss of weight (GV) from start weight (SG)



0 – 100%



Dry mass [%] = residual weight (RG) of SG



100% - 0 %



ATRO [%] = $SG : RG \times 100\%$



100 – 999 %



Current temperature



Remaining time

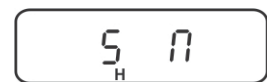

Using the **ON/OFF** button drying can be finished at any moment if required.

- ⇒ When drying is finished, you will hear an acoustic signal and the heating will be shut off. The indicator „OK“ displays the measuring result. Use the **MENU** button to switch over into the result display.



Moisture [%]



Dry mass [%]



ATRO [%]



Residual weight in „g“

- ⇒ When an optional printer is connected, the measurement log will be edited independently on the settings in the menu, see chap. 11.3
- ⇒ For further measurement press the **ON/OFF** button, the appliance returns into the menu.
- ⇒ For exiting the menu press anew the **ON/OFF** button, the appliance returns into weighing mode
- ⇒ Open the sample chamber and remove the sample with the help of the removal aid.
Caution: Caution! Sample dish and all parts of the sample chamber are hot!

10.1.3 Moisture analysis with drying program PrG Auto Mode

Drying will be completed, when the set loss of weight (available 0.1 - 9.9% humidity) per time unit (60 sec) is less than the nominal value.

PrG Auto

- ⇒ Confirm by pressing the **PRINT** button. The currently set nominal value is displayed.

1.0 dMin

- ⇒ Use the navigation buttons **↓** **↑** to select the desired setting.
- ⇒ Confirm by pressing the **PRINT** button. The currently set drying temperature is displayed.

120 C

- ⇒ Use the navigation buttons **↓** **↑** to select the desired setting.
- ⇒ Confirm by pressing the **PRINT** button. The query whether the preheating stage „PrH“ shall be connected, will appear.

PrH no



PrH YES

- ⇒ Use the navigation buttons **↓** **↑** to select the desired setting.

PrH no = preheating stage switched off
PrH yes = preheating stage connected

Start of moisture analysis:

Preheating stage enabled

A rectangular digital display showing the text "PrH 4E5".

- ⇒ Confirm by the **PRINT** button, close the sample chamber and wait for the warm-up phase.

A rectangular digital display showing the text "WAIT" with a small "H" centered below it.

- ⇒ After reaching the set temperature „ready“ will be displayed.

A rectangular digital display showing the text "r-ERdy".

- ⇒ Confirm by pressing the **PRINT** button. The weight display and the indicator „▼“ are displayed.
- ⇒ If required, tare by using **TARE** button.

A rectangular digital display showing "0.000 g" with a small "H" and a downward arrow "▼" below the first zero.

- ⇒ Put prepared sample (see chap. 12.4) in the sample dish and close the sample chamber.

A rectangular digital display showing "5.000 g" with a small "H" and a downward arrow "▼" below the first zero.

- ⇒ Wait for stability display, then press the **PRINT** button. Drying is started.

A rectangular digital display showing "0.00 n" with a small "H" and a percentage sign "%" below the first zero.

The result display appears.

The indicator „H“ displays the active drying process.

Preheating stage disabled

A rectangular digital display showing the text "PrH no".

- ⇒ Confirm by pressing the **PRINT** button. The weight display and the indicator „▼“ are displayed.
- ⇒ If required, tare by using **TARE** button.

A rectangular digital display showing "0.000 g" with a small "H" and a downward arrow "▼" below the first zero.

- ⇒ Put prepared sample (see chap. 12.4) in the sample dish and close the sample chamber.

A rectangular digital display showing "5.000 g" with a small "H" and a downward arrow "▼" below the first zero.

- ⇒ Wait for stability display, then press the **PRINT** button. Drying is started.

A rectangular digital display showing "0.00 n" with a small "H" and a percentage sign "%" below the first zero.

The result display appears.

The indicator „H“ displays the active drying process.

- ⇒ During drying the display can be switched over by repeated pressing of the **MENU** button.

Moisture [%] = loss of weight (GV) from start weight (SG)



0 – 100%



Dry mass [%] = residual weight (RG) of SG



100% - 0 %



ATRO [%] = $SG : RG \times 100\%$



100 – 999 %



Current temperature



Remaining time

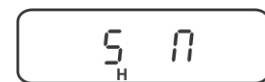

Using the **ON/OFF** button drying can be finished at any moment if required.

- ⇒ When drying is finished, you will hear an acoustic signal and the heating will be shut off. The indicator „OK“ displays the measuring result. Use the **MENU** button to switch over into the result display.



Moisture [%]



Dry mass [%]



ATRO [%]



Residual weight in „g“

- ⇒ When an optional printer is connected, the measurement log will be edited independently on the settings in the menu, see chap. 11.3
- ⇒ For further measurement press the **ON/OFF** button, the appliance returns into the menu.
- ⇒ For exiting the menu press anew the **ON/OFF** button, the appliance returns into weighing mode
- ⇒ Open the sample chamber and remove the sample with the help of the removal aid.
Caution: Caution! Sample dish and all parts of the sample chamber are hot!

10.2 Save the drying programs PrG1, PrG2, PrG3, PrG4, PrG5

The appliance has more than 5 memory locations for often used drying programs. For every drying program the respective drying parameters are stored, which may be invoked and started according to needs (see chap. 10.1.1)

⇒ In weighing mode press the **MENU** button, „Therm“ is displayed.

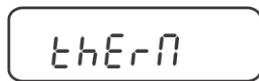

⇒ Acknowledge using **PRINT** button, „Measure“ is displayed.

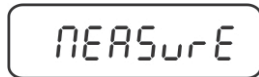

⇒ Use the navigation buttons **↓** **↑**, „PrG Set“

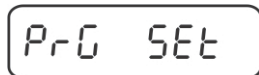

⇒ Confirm by pressing the **PRINT** button.

⇒ Use the navigation buttons **↓** **↑** to select the desired drying program.

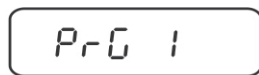

.....

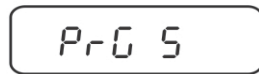

⇒ Confirm with the **PRINT** button, the currently set drying mode will be displayed.

PrG Auto



PrG time

- ⇒ Use the navigation buttons **↓** **↑** to select the desired drying mode.
- ⇒ Acknowledge using **PRINT** button, the current setting is displayed. Enter the drying parameters as specified in chap. 10.1.2 (PrG time) and chap. 10.1.3 (PrG Auto).
- ⇒ Confirm using the **PRINT** button, the query „Save no / yes“ appears.
- ⇒ Use the navigation buttons **↓** **↑** to select the desired setting.

SAVE no

Do not save



SAVE YES

store

- ⇒ Confirm using the **PRINT** button, the appliance returns into the menu.
- ⇒ For exiting the menu press anew the **ON/OFF** button, the appliance returns into weighing mode.

11 RS 232C interface

The moisture analyser is typically equipped with a RS 232C interface.

The following conditions must be met to provide successful communication between the moisture analyser and the printer.

- Use a suitable cable to connect the moisture analyser to the interface of the printer. Faultless operation requires an adequate KERN interface cable.
- Communication parameters (baud rate, bits and parity) of moisture analyser and printer must match.
- Data may only be transferred in moisture analysis mode.

The measurement data may be edited according to the setting in the menu item „Serial“ (see chap. 11.3) or automatically or by pressing the **PRINT** button via the interface.

11.1 Technical data

- 8-bit ASCII Code
- 8 data bits, 1 stop bit, no parity bit
- Baudrate selectable from 1200 - 9600 Baud , see chap. 9.1.1
- For operation with interface faultless operation is only ensured with the correct KERN – interface cable (max. 2m)

11.2 Pin allocation of the output plug

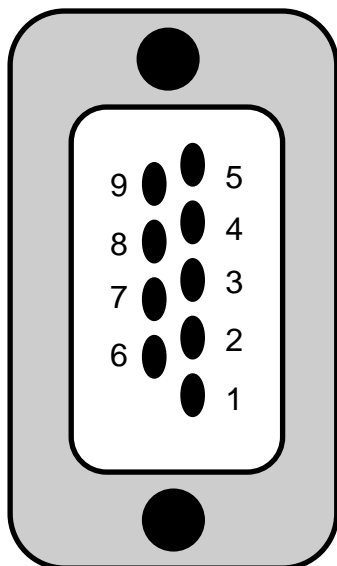

Pin 2:	Tx Signal
Pin 3:	Rx Signal
Pin 5:	GND

11.3 Menu settings „Serial“

⇒ In weighing mode press the **MENU** button, „Therm“ is displayed.

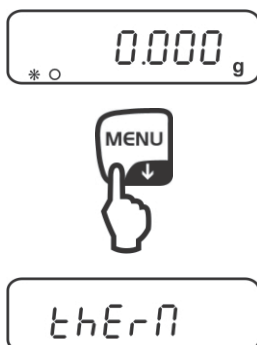

⇒ Acknowledge using **PRINT** button, „Measure“ is displayed.

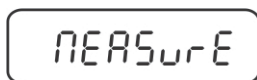

⇒ Use the navigation buttons to select ↓ ↑ „Serial“

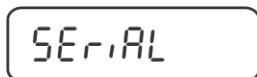

⇒ Acknowledge using **PRINT** button, the current setting is displayed.

⇒ Use the navigation buttons ↓ ↑ to select the desired setting.

Manu Prt	Not documented
Auto Prt	Not documented
Manu PC	Data output after pressing the PRINT button
Auto PC	Automatic data output
Weig PC	Continuous data output residual weight
Manu T50	Not documented
Auto T50	Not documented

⇒ Select using the **PRINT** button, the appliance returns into the menu.

⇒ For exiting the menu press anew the **ON/OFF** button, the appliance returns into weighing mode

11.3.1 Printout examples (YKB-01N)

1. Menu setting „Serial“→“Manu PC“

Printout occurs when drying is completed by pressing the **PRINT** button.

Temp.	130	°C	Drying temperature
Time:	5	Min	Drying time
W.Start	19.998	g	Start weight

W-End:	19.994	g	Residual weight
Moist.:	0.02	%	Moisture [%]

2. Menu setting „Serial“→“Auto PC“

The first part of the printout occurs automatically when drying starts

Temp.	130	°C	Drying temperature
Time	5	Min	Drying time
W.Start	19.998	g	Start weight

The second part of the printout occurs automatically when drying is completed			

W-End:	19.994	g	Residual weight
Moist.:	0.02	%	Moisture [%]

12 General information concerning moisture analysis

12.1 Application

In all cases where moisture is added to or removed from products, a fast determination of the moisture content is of enormous importance. For countless products the moisture content is not only a quality feature but also an important cost factor. Very often fixed limits for moisture content apply to the trade in industrial or agricultural goods as well as chemical or food products which are defined by terms of delivery and general standards.

12.2 Basics

Moisture does not only mean water but includes all substances that evaporate when heated up. In addition to water this includes,

- Fats
- Oils
- Alcohol
- Solvents
- etc...

There are various methods to analyse moisture in a product.

KERN MLB uses a method called thermogravimetrics. In accord with this method, the sample is weighed before and after heating, determining the material moisture by looking at the difference.

The conventional drying chamber method follows the same principle, with the exception that this method requires a considerably longer measuring period. . In accord with the drying chamber method, the sample is heated from the outside to the inside by a hot air current, so as to remove the moisture. The radiation applied in the KERN DLB penetrates mainly the sample in order to be transformed inside it into heat energy that is, warming from the inside to the outside. A minor amount of radiation is reflected by the sample, a reflection that is less in dark samples than in light-coloured ones. The depth of penetration of the radiation depends on the permeability of the sample. In samples of low permeability the radiation only penetrates the outer layers of the sample, possibly resulting in imperfect drying, incrustation or burning. For that reason the preparation of a sample is of great importance.

12.3 Adjustment to existing measuring method

Quite frequently the KERN DLB replaces a different drying method (such as a drying chamber) as the KERN DLB achieves shorter measuring times during a simplified operation. For that reason the conventional measuring method must be matched to the KERN DLB in order to achieve comparable results.

- Carry out parallel measurement
 - Lower temperature setting for KERN DLB than drying chamber method
- Result of KERN DLB does not match reference
 - Repeat measurement with changed temperature setting
 - Vary shutoff criterion

12.4 Preparing a sample

Prepare one sample at a time for measuring. This prevents the sample from exchanging moisture with its surroundings. If several samples have to be taken at the same time, they should be packed in airtight boxes so that they do not undergo changes during storage.

To receive reproducible results, spread the sample thinly and evenly on a sample dish. Patchy spreads will produce inhomogeneous heat distribution in the sample to be dried resulting in incomplete drying and increased measuring time. Sample clusters generate increased heating of the upper layers resulting in combustion or incrustation. The high layer thickness or possibly arising incrustation makes it impossible for the moisture to escape from the sample. Due to this residual moisture, measured results calculated in this way will not be comprehensible or reproducible.

Preparing a sample from solids:



- Spread powdery or grainy samples evenly on the sample dish.
- Grind coarse samples using a mortar or a shredder. When grinding the sample avoid any heat supply as this may cause loss of humidity.

Preparing a sample from liquids:



For liquids, pastes or melting samples we recommend to use a glass fibre filter. The glass fibre filter has the following advantages:

- Even distribution thanks to capillary attraction
- no formation of droplets
- fast evaporation due to a greater surface

12.5 Sample material

Easy to determine are usually samples with the following characteristics:

- Grainy to powdery, pourable solids
- Thermally stable materials, emitting the moisture to be determined easily without other substances evaporating at the same time
- Liquids that vaporize to leave a dry substance without developing a film

Difficult to determine may be samples that are:

- Glutinous or sticky
- Become incrustrated easily or tend to form a film
- Decompose easily under the influence of heat or emit various elements

12.6 Sample size / originally weighted in quantity

Drying times, as well as achievable accuracy, are significantly influenced by sample distribution. In the course of this arise two opposed requirements:

The lighter the originally weighted in quantity, the easier it is to achieve shorter drying times.

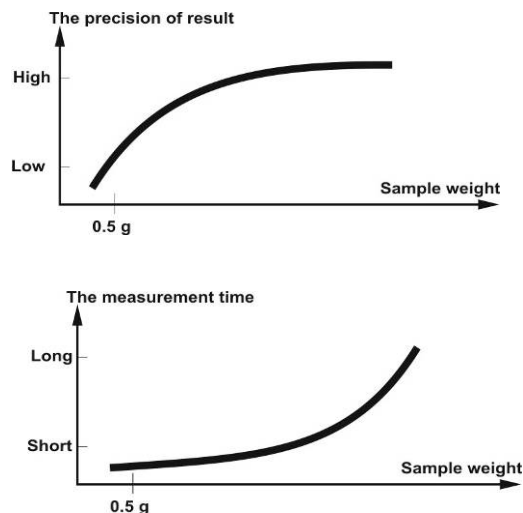

However, the heavier the originally weighted in quantity, the more accurate a result.

12.7 Drying temperature

Bear in mind the following factors when setting the drying temperature:

Surface of the sample:

Compared with powdery or grainy samples, liquid and spreadable samples have a smaller surface for the transmission of heat energy.

The use of a glass fibre filter improves the heat application.

Colour of sample:

Light-coloured samples reflect more heat radiation than dark ones and therefore require a higher drying temperature.

Availability of volatile substances:

The better and faster the water or other volatile substances can be disposed, the lower a drying temperature is required. If water is difficult to get to (e. g. in synthetics), it has to be calcined at high temperatures (the higher the temperature, the higher the water vapour pressure).

Results equivalent to other moisture analysing methods (e. g. drying chamber) can be achieved by experimentally optimising the setting parameters such as temperature, heating level and shutoff criteria.

12.8 Recommendations / Guidelines

Prepare standard sample:

- Crush sample, as required, and spread it evenly in the aluminium dish.

Prepare special samples:

- For sensitive or hard to spread test materials (e. g. mercury) a glass fibre filter is available for use.
- Apply the sample equally on the glass fibre filter and cover it with a second glass fibre filter.
- The glass fibre filter is also useful as a protection when splashing materials are dealt with (each splash falsifies the final result).

Table of applications:



Material	Weight Sample (g)	Drying temperature (°C)	Drying period (approx.) (min)	Moisture (approx.)	Solid body % (approx.)
ABS (Novodur P2H-AT)	10	60	10	0,11	
Accumulator lead	10	110	2,6	0,19	
Acryl granulate	10-15	80	12	0,18	
Activated carbon	10	80	9,8	13,33	
Activated carbon	7,6	80	4,1	6,12	
Sliced pineapple	5	110	14,4	6,71	
Sliced apple (dry)	5-8	100	10-15	76,5	
Sliced apple (humid)	5-8	100	5-10	7,5	
Artesan powder	0,5	80	3,5		98,44
Aspartame granulate	0,5	105	3,4		96,84
Bath milk	3	80	27,4	83,87	
Cotton seed	3-4	110	6,3	6,8	
Blue-veined cheese	2	160	13,3		53,06
Body lotion	3	80	31,6	87,76	
Beans	4,5	150	9,7	11,85	
Butter	1,7	140	4,3		84,95
Acetyl cellulose	5,5-6	50	1,3	0,81	
Chinese Virility powder	2,5-3	110	5,5	6,24	
CN photographic paper	2	150	6,4	5,81	
Cornflakes	2-4	120	5-7	9,7	
Roof tile mass	2,5	160	10		81,74
Roof tile mass	7	160	20		81,74
Dialysis membrane (Polyethes – polycarbonate)	0,5	80	2,2	7,85	
Dialysis membrane (Polyethes – polycarbonate)	0,5-0,7	80	2,0	7,86	
Indoor sealing compound	3	160	7		64,04
Dispersion adhesive	1,5	140	9,5		55,69
Dispersion adhesive (watery)	2,5	155	7,2	43,77	
Dolomite	10-12	160	6,1	0,06	
Printer ink fluid	1,5	120	10		19,15
E-filter dust of waste incineration	7-10	135	7	26,23	
Peas, „danish yellow“	3,5	135	7,9	15,19	
Peanut cores	2,8	100	4	1,97	
Peanut cores	3	100	6	3,2	
Refreshment candies	3-3,4	90	2,9	0,29	
Dye powder	1,5	120	3,5		99,07
Fine ceramic mass	2,5	160	9		86,89
Film waste	8-9	60	1,2	0,4	
River water	4	160	20	99,2	
Fudge/sugar mass	5	130	20	8	
Formaldehyde urea dispersion	2	155	7,6	34,07	
Cottage cheese	1,4	70	15		41,03
Forage pellets	3-4	150	5,7	6,35	
Dried beans	3-4	105	5	7,3	
Dried peas	5-7	110	9,6	5,89	
Dried carrots	5,5-6	120	3	4,92	
Dried chicken dung	4	140	8	14,81	
Dried corn	5-7	110	10	6,21	
Glass powder	8-10	160	5	0,26	

Material	Weight Sample (g)	Drying temperature (°C)	Drying period (approx.) (min)	Moisture % (approx.)	Solid body % (approx.)
Setting lotion	0,01	145	9	98,76	
Setting lotion (extra strong)	1	130	8	97,85	
Hair styling gel	5	105	37,0	94,71	
Oat flakes	2	105	5,6	9,35	
Hazelnut cores	2,2	100	3,8	4	
Hazelnut cores (peeled)	2,6	100	4,5	3,74	
Hydranal sodium ttrate – 2 – hydrate	1,6	160	12	15,67	
Yoghurt	2-3	110	4,5-6,5	86,5	
Coffee	2	150	8	4,99	
Coffee cream	2-3	130	6-8	78,5	
Coffee seed	3,5-4	120	8	8,53	
Cocoa	2,5	105	4	3,45	
Cocoa seed	4-5	130	7,8	6,23	
Limestone	12-14	160	5	0,05	
Potato powder	2,5-3,0	130	5,8	12,46	
Potato chips	3-4	106	7,5	6,9	
Ketchup	2	120	18	74,44	
Silica gel	9,5	115	4,5	0,63	
Adhesive	2-5	136	6-8	54,3	
Garlic, powder	2	100	7,3	5,36	
Coal powder	4	160	3,4	2,11	
Chalk (natural)	8	160	1,7	0,06	
Crystal sugar	3	90	2,8	0,05	
Synthetic resin dispersion (diluted)	2	160	5,9	60,21	
Latex	1-2	160	5,2	38,64	
Latex LE ¹	3-5	125	10,8	46,58	
Latex LE ²	3-5	125	9,4	50,37	
Latex O44	3-5	125	9,4	50,65	
Lentils	4	135	5,4	12,49	
Loam soil	10-15	160	5,5	9,89	
Loam clay	2,5	160	14,5		80,75
Skim milk powder	4	90	5,5	3,67	
Low fat curd cheese	1,2	130	8		18,5
Corn starch	2	160	5,2		89,1
Almonds (caramelised)	3,5	80	4,8	1,81	
Almonds (natural)	2,5	100	5,3	4,19	
Almonds „californian“	3	100	5,3	4,34	
Margarine	2,2	160	4	19,15	
Brick mass	7	160	20		80,13
Mayonnaise	1-2	138	10	56,5	
Flour	8-10	130	4,5	12,5	
Micronyle	7-8	60	8	0,4	
Milk	2-3	120	6-8	88	
Milk powder (MMP)	4,5	100	6,3	2,46	
Milk powder (VMP)	4,5	100	5,5	2,56	
Mozzarella	1,5	160	11,1		45,78
Multivitamin candies	3-3,4	115	3,3	0,4	
Natural latex	1,4	160	5,3	42,56	
Nougat mass	2,5	103	10	0,6	
Noodle dough	0,55	160	5	12	
Concentrated orange juice	2-3	115	13	52,1	

Material	Weight Sample (g)	Drying XXXX temperature (°C)	Drying period (approx.) (min)	Moisture % (approx.)	Solid body % (approx .)
Paper	2-4	106	10	6,4	
PA 6 (Ultramide B3WG5)	10	60	10	0,05	
PA 6.6 (Ultramide B3WG5)	10	80	10	0,15	
PBTP (Crastin SK645FR)	10	80	10	0,05	
PC (Macrolon 2805)	10-12	80	15	0,08	
PC/ABS (Babyblend T65MN)	9-11	80	10	0,12	
Pepper, black, powder	2	85	8,8	7,97	
PMMA (Plexiglass 6N)	10	70	10	0,12	
Polypropylene	13	130	9	0,23	
Polypropylene	3,3	120	2,2	0,09	
Polystyrene sulfonic acid Sodium salt solution	2-2,5	120	8,7	19,01	
POM (Hostaform C9021))	10	80	10	0,13	
PS (Polystyrene 168 N)	10	80	10	0,05	
Purine	2	105	3,8	8,64	
Curd	1	140	7		18
Curd cheese, „Fat curd cheese“	1,2	130	8		23
Silica sand	10-14	160	1,9	0,24	
Raclette cheese	1,5	160	14,4		56,9
Canola seed	3-4	90	7,4	6,18	
Rice (US parboiled)	3,5	105	12,5	10,98	
Rye	4,5	150	11,5	10,72	
Red wine	3-5	100	15-20	97,4	
Sugar beet pulp pellets	4,5	150	8,6	11,77	
Salt	2	100	3	4,9	
Pretzel sticks	3-4	75	4,5	1,67	
Sludge	11-12	130	90	80	
Melted cheese	1,5	70	15	35,65	
Chocolate	2,5	103	10	0,5	
Chocolate powder	2-4	100	4	1,9	
Chocolate water	2-3	90	10		6
Hogwash of kitchen waste	4-5	160	21		17,67
Lard	0,70	160	3,5	1,2	
Shampoo	2	100	14,1	75,89	
Soap	3	120	6	7,86	
Mustard	2,5-3	80	19		34,69
Sesame seed	3	130	8	5,48	
Soya bean flour	4,6	95	4,9	4,8	
Soya beans, granulate	5	110	22,6	12,16	
Bruised sunflower seed	3-3,5	100	4	5,92	
Sunflower oil	10-14	138	2	0,1	
Spaghetti	3	105	15,1	10,63	
Rinsing agent	2	80	13,7	59,64	
Dust	5-10	104	8-15	7,3	
Starch derivative	2,5	150	12,3		30,29
Starch glue	1,5	100	8,9		17,96
Spread cheese	2,5-2,8	160	4,5		36,81
Soup (instant product)	2-3	80	4,5-7	3	

Material	Weight Sample (g)	Drying temperature (°C)	Drying period (approx.) (min)	Moisture % (approx.)	Solid body % (approx.)
Tobacco	1,5	100	16	10,18	
Tea, black	2	105	4	7,67	
Pasta	1,5	120	8	10,64	
Textile fibre	0,8-1,2	85	3,6	14,03	
Theophylline	1,5	130	1,9	7,33	
Thermoplastic PUR – granulate	15-18	80	18	0,08	
Walnut	2,8	100	5,6	3,5	
Washing powder	2	160	12	7,32	
Wheat spring water	2-3	90	10		6
Sausage casing	0,2	150	3,5		78,56
Toothpaste	2	100	7,7	34,28	
Pulp	2,5	130	4,5	7,32	
Cement	8-12	138	4-5	0,8	
Sugar	4-5	138	10	11,9	
Sugar beets	2	130	13,4		30,94

13 Error messages

ERR01	Weight value instable or zeroing not possible. Check the environmental conditions.
ERR02	Adjustment error, e.g. instable environmental conditions
ERR03	Adjustment error e.g. incorrect adjustment weight}
ERR05	Data transfer not possible, as weighing value is instable. Check the environmental conditions.
ERR07	Faulty data reading
ERR10	Instable display when drying starts, check environmental conditions
ERR11	Sample weight too small
“UNLOAD”:	Sample or sample dish wrongly positioned.
“Err thb”	Heating top does not work, check current supply
	Weighing range exceeded, placed load exceeds the capacity of the appliance. Unload appliance.
	Weighing range not reached, e.g. Dish holder / removal help is missing.

14 Service, maintenance, disposal



Before any maintenance, cleaning and repair work disconnect the appliance from the operating voltage.

14.1 Cleaning

Please do not use aggressive cleaning agents (solvents or similar agents), but a cloth dampened with mild soap suds. Ensure that no liquid penetrates into the device. Polish with a dry soft cloth.

Loose residue sample/powder can be removed carefully with a brush or manual vacuum cleaner.

Spilled weighing goods must be removed immediately.

14.2 Service, maintenance

- ⇒ The appliance may only be opened by trained service technicians who are authorized by KERN.
- ⇒ Ensure that the balance is regularly calibrated, see chap. Testing instruments control.

14.3 Disposal

- ⇒ Disposal of packaging and appliance must be carried out by operator according to valid national or regional law of the location where the appliance is used.

15 Instant help

Fault

Possible cause

Display is not lit up.

- The display unit is not switched on.
- The mains supply connection has been interrupted (mains cable not plugged in/faulty).
- Power supply interrupted.

Measurement is taking too long

- Incorrect setting shutoff criterion

Measurement is not reproducible

- Sample is not homogenous
- Drying time is too short
- Drying temperature too high (e.g. oxidation sample material, boiling point of sample exceeded)
- Temperature sensor soiled or defective
- Draught/air movement
- Table/floor vibrations
- Electromagnetic fields / static charging (choose different location/switch off interfering device if possible)

The displayed weight is permanently changing

16 Declaration of conformity

Declaration of conformity

EC-Konformitätserklärung
EC- Déclaration de conformité
EC-Dichiarazione di conformità
EC- Declaração de conformidade
EC-Deklaracja zgodności

EC-Declaration of -Conformity
EC-Declaración de Conformidad
EC-Conformiteitverklaring
EC- Prohlášení o shode
ЕС-Заявление о соответствии

D	Konformitäts- erklärung	Wir erklären hiermit, dass das Produkt, auf das sich diese Erklärung bezieht, mit den nachstehenden Normen übereinstimmt.
GB	Declaration of conformity	We hereby declare that the product to which this declaration refers conforms with the following standards.
CZ	Prohlášení o shode	Tímto prohlašujeme, že výrobek, kterého se toto prohlášení týká, je v souladu s níže uvedenými normami.
E	Declaración de conformidad	Manifetamos en la presente que el producto al que se refiere esta declaración está de acuerdo con las normas siguientes
F	Déclaration de conformité	Nous déclarons avec cela responsabilité que le produit, auquel se rapporte la présente déclaration, est conforme aux normes citées ci-après.
I	Dichiarazione di conformità	Dichiariamo con ciò che il prodotto al quale la presente dichiarazione si riferisce è conforme alle norme di seguito citate.
NL	Conformiteit- verklaring	Wij verklaren hiermede dat het product, waarop deze verklaring betrekking heeft, met de hierna vermelde normen overeenstemt.
P	Declaração de conformidade	Declaramos por meio da presente que o produto no qual se refere esta declaração, corresponde às normas seguintes.
PL	Deklaracja zgodności	Niniejszym oświadczamy, że produkt, którego niniejsze oświadczenie dotyczy, jest zgodny z poniższymi normami.
RUS	Заявление о соответствии	Мы заявляем, что продукт, к которому относится данная декларация, соответствует перечисленным ниже нормам.

Electronic Balance: KERN DLB_A

Mark applied	EU Directive	Standards
CE	2004/108/EC	EN 61326-1:2006
	2006/95/EC	EN 61010-1:2001

Date: 14.04.2011

Signature: 

KERN & Sohn GmbH
Management

KERN & Sohn GmbH, Ziegelei 1, D-72336 Balingen, Tel. +49-[0]7433/9933-0
Fax +49-[0]7433/9933-149, E-Mail: info@kern-sohn.com, Internet: www.kern-sohn.com

17 Short instructions for moisture analysis

Call up menu: **MENU**-key

Exit menu: Press **MENU** button long time

Scroll to next page: **MENU**-key

Scroll to previous page: **CAL**-key

Confirm **PRINT** button

